



A Scenic Design Process  
*Mr. Burns a post-electric play*

By Naoko Skala

# <Table of Contents>

Research (Inspirational).....	p. 3-8
Research (Conceptual).....	p. 9-45
Act 1 .....	p. 9-13
Act 2 .....	p. 14-40
Act 3 .....	p. 41-45
Colored Rendering,Ground Plan and 3D Model....	p. 46-56
Act 1 .....	p. 46-48
Act 2 .....	p. 49-52
Act 3 .....	p. 53-56
Drafting.....	p. 57-64
Paint Sample.....	p. 65-72

# Inspirational Images



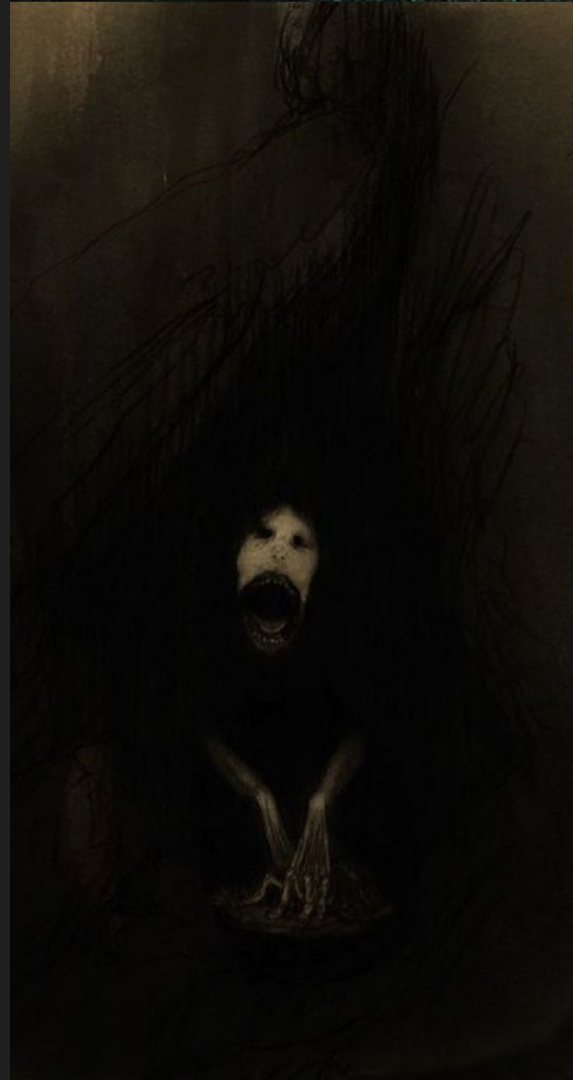



Hidden Depths

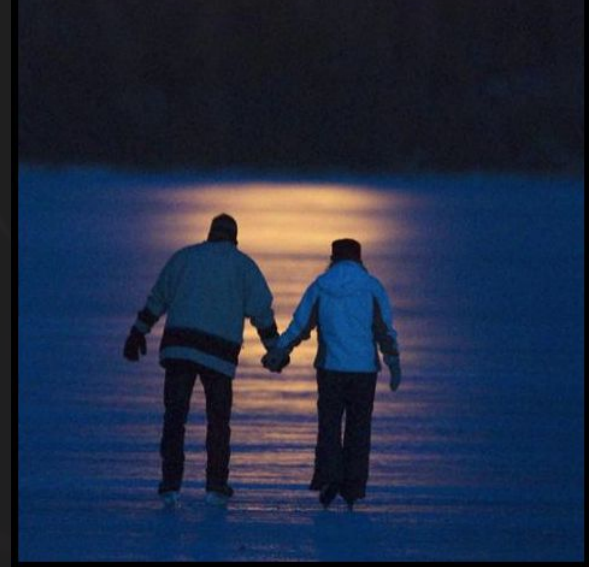





# Conceptual Images

Act 1









# Conceptual Images

Act 2



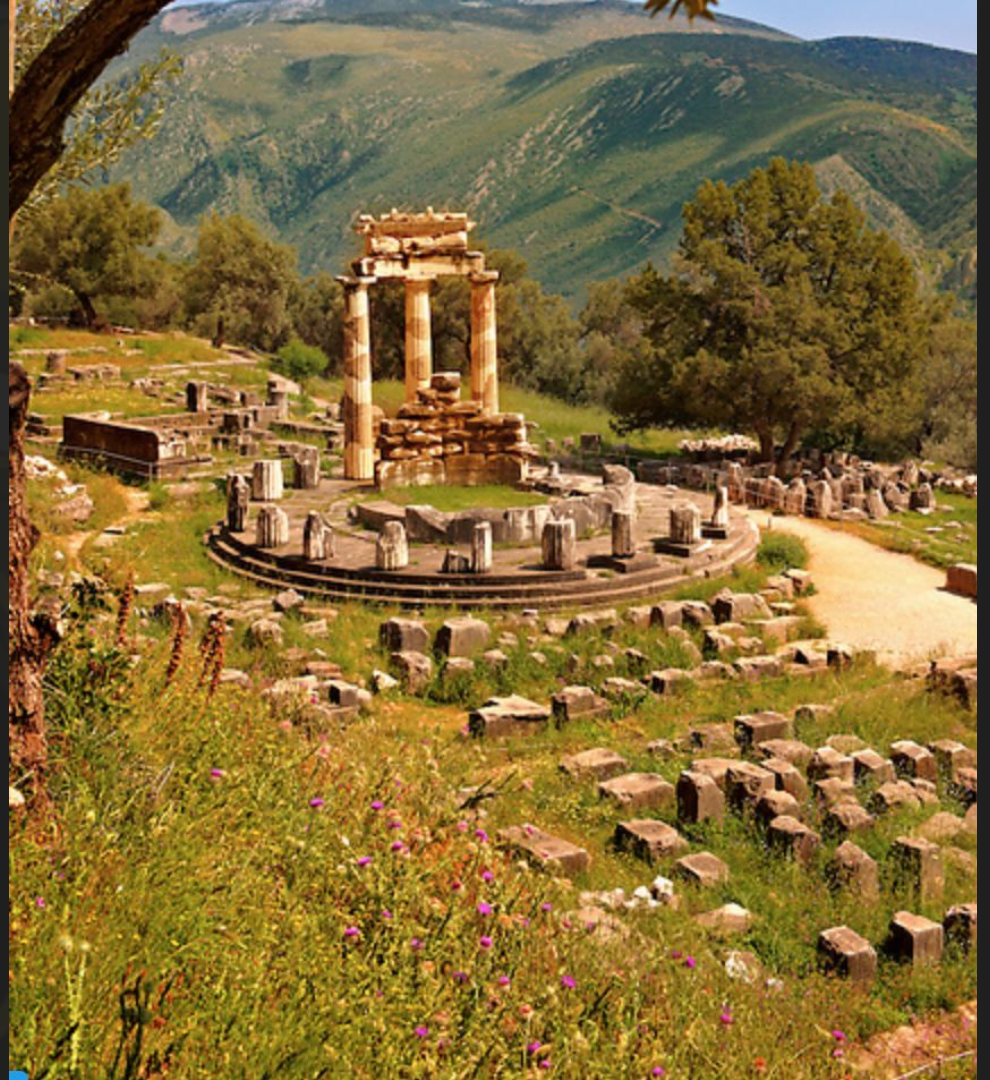





AMPHITHEATRE.  
N° 1. Restored to its Architecture. Plate II.

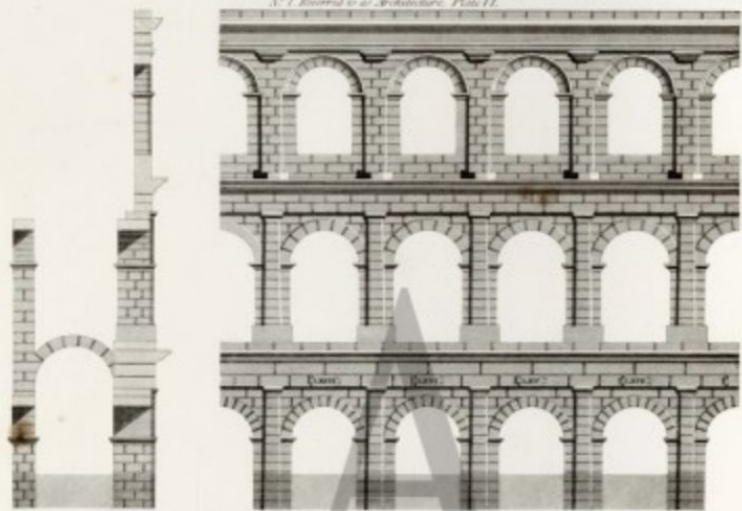

N° 2. Restored to its Architecture. Plate III.

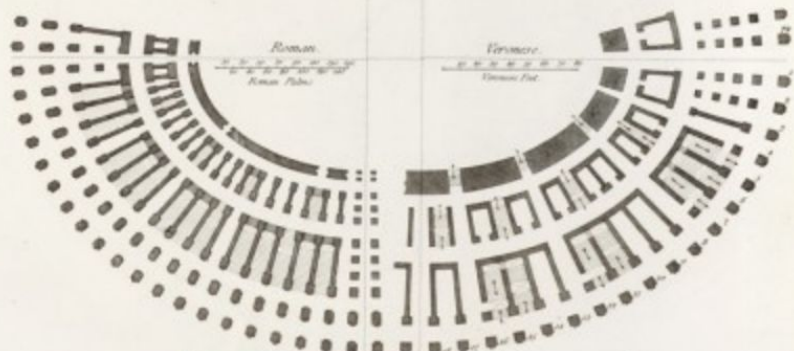



P 6885



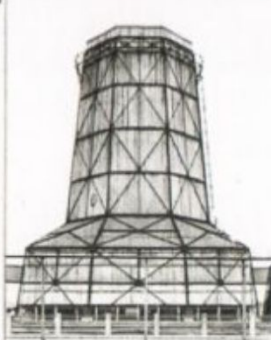
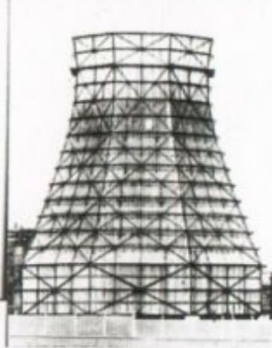
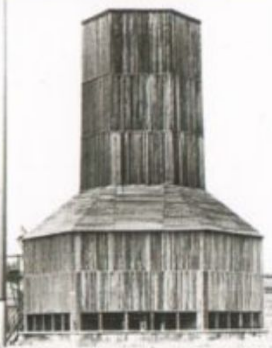
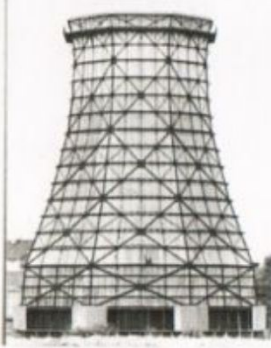

Phipps Bend Nuclear Power Plant (Surgoinsville, TN) [OC] [4000x2250]







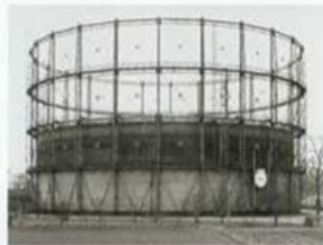



































# Conceptual Images

Act 3











# Colored Rendering Ground Plan

Act 1



37	CYC
36	
35	
34	
33	Electric 4
32	Electric 4A
31	Column Legs 3
30	Legs 4
29	Barter 4
28	
27	
26	
25	
24	Tree Cut Drop
23	Black Scrim
22	Electric 3A with Rope
21	
20	Electric 3
19	Column Legs 2
18	Legs 3
17	Barter 3
16	Pipe Structure
15	
14	
13	Electric 2A
12	Electric 2
11	Column Legs 1
10	Legs 2
9	Barter 2
8	
7	
6	Electric 1A
5	
4	Electric 1
3	Legs 1
2	Main Curtain
1	Main Barter

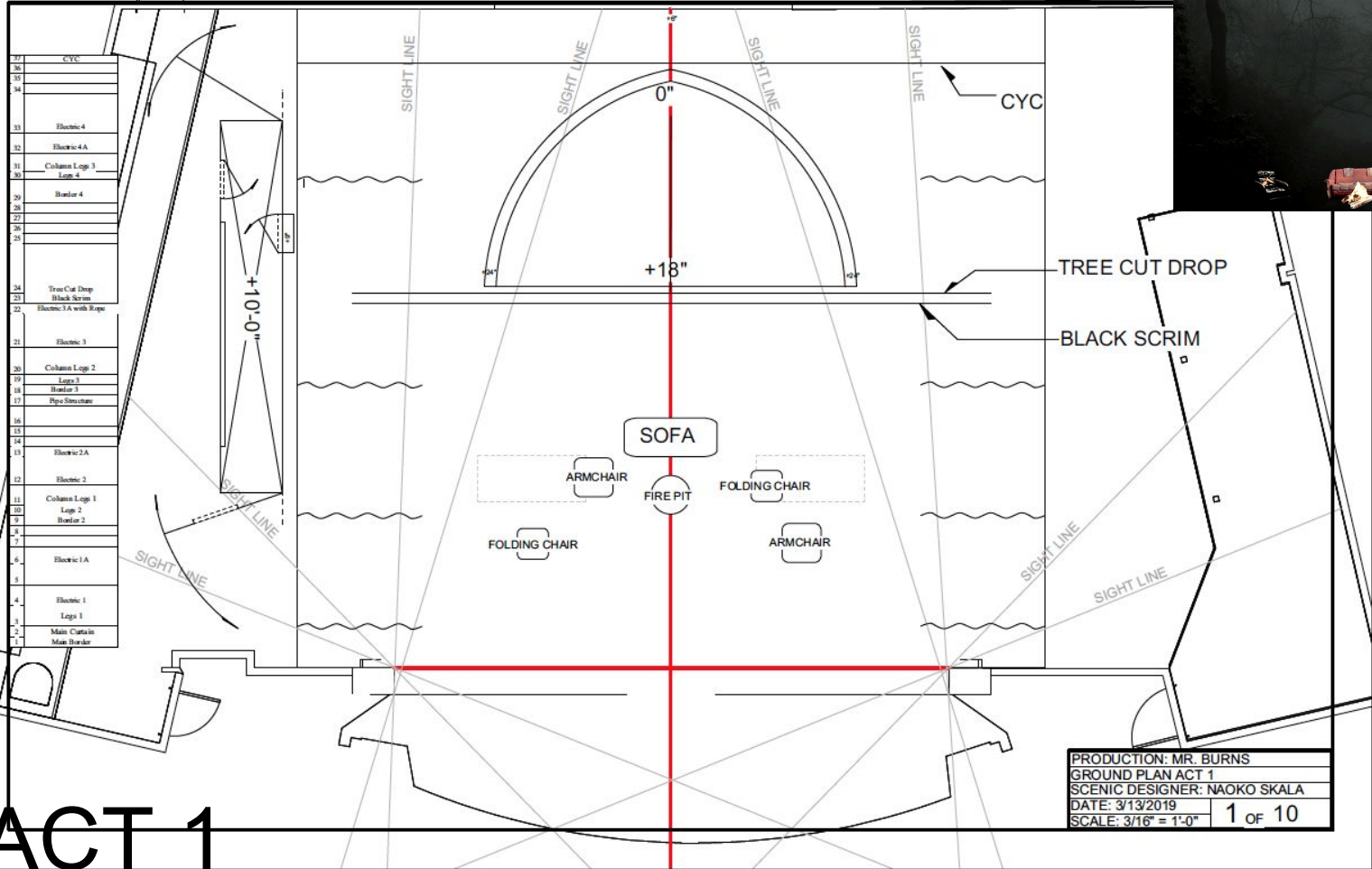

PRODUCTION: MR. BURNS
GROUND PLAN ACT 1
SCENIC DESIGNER: NAOKO SKALA
DATE: 3/13/2019
SCALE: 3/16" = 1'-0"      1 of 10

# ACT 1

# Colored Rendering Ground Plan 3D Model

Act 2





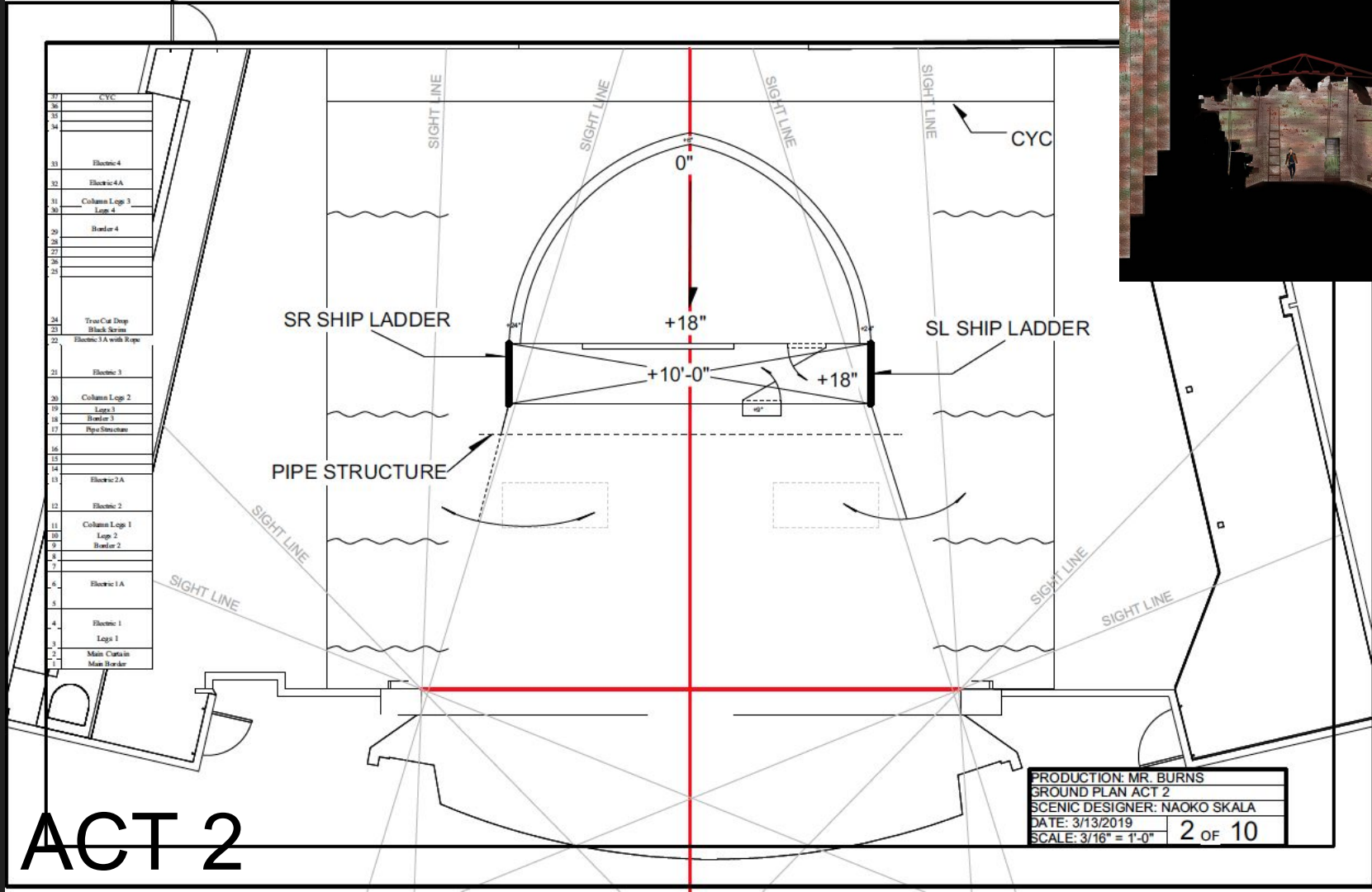

- 32 CYC
- 31 Electric 4
- 30 Electric 4A
- 29 Cushman Legs 3  
Legs 4
- 28 Border 4
- 27
- 26
- 25
- 24
- 23
- 22
- 21
- 20
- 19
- 18
- 17
- 16
- 15
- 14
- 13
- 12
- 11
- 10
- 9
- 8
- 7
- 6
- 5
- 4
- 3
- 2
- 1

SR SHIP LADDER

SL SHIP LADDER

PIPE STRUCTURE

CYC

SIGHT LINE

PRODUCTION: MR. BURNS
GROUND PLAN ACT 2
SCENIC DESIGNER: NAOKO SKALA
DATE: 3/13/2019
SCALE: 3/16" = 1'-0"

# ACT 2



# Colored Rendering Ground Plan 3D Model

Act 3



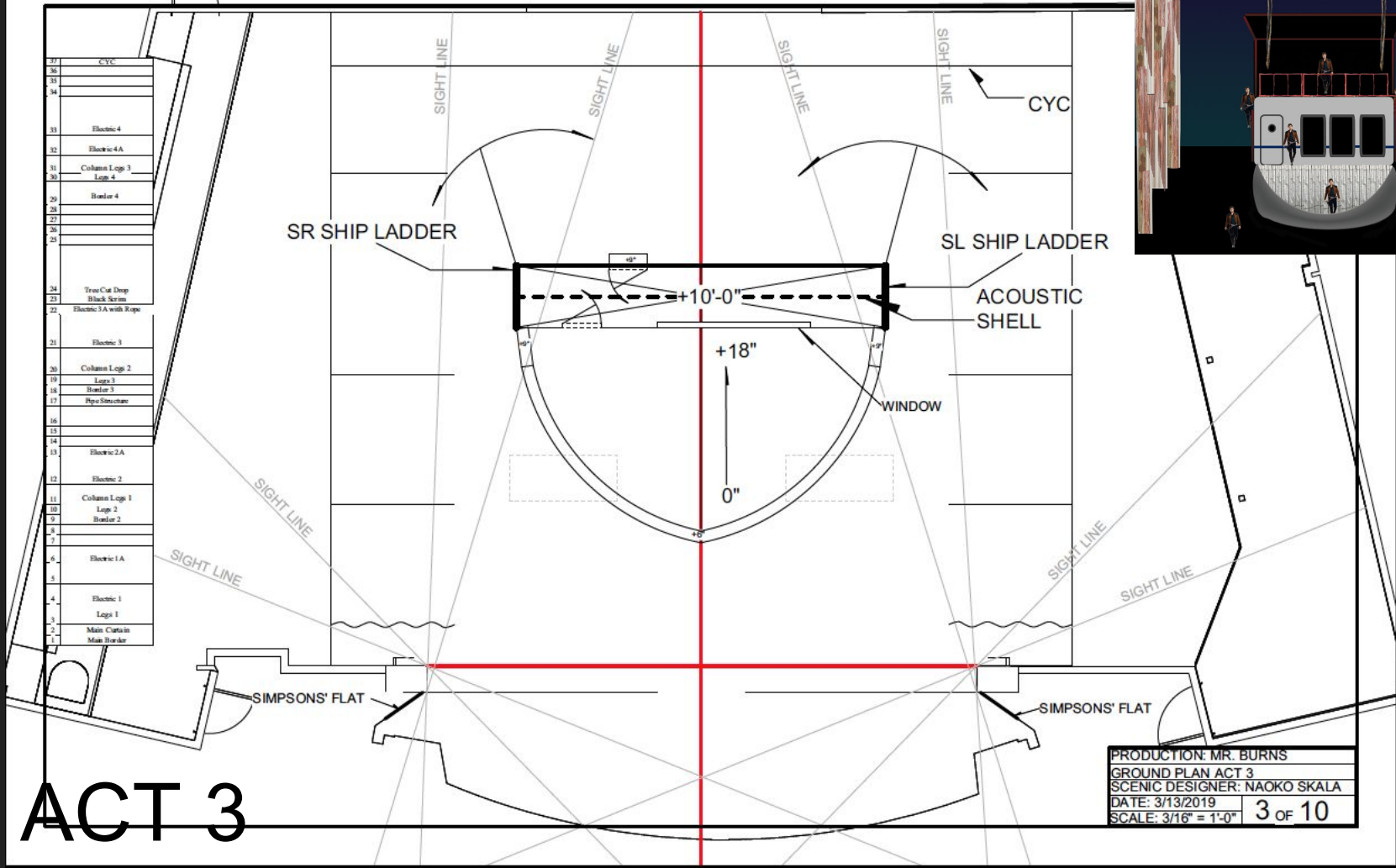

# ACT 3



Drafting



19'-9"



36'-0"

FRONT ELEVATION / DETAIL DRAWING

TREE DROP

DRAFTER: NAOKO SKALA

DATE: 4/11/2019

SCALE: 3/8" = 1'-0"

4 OF 10

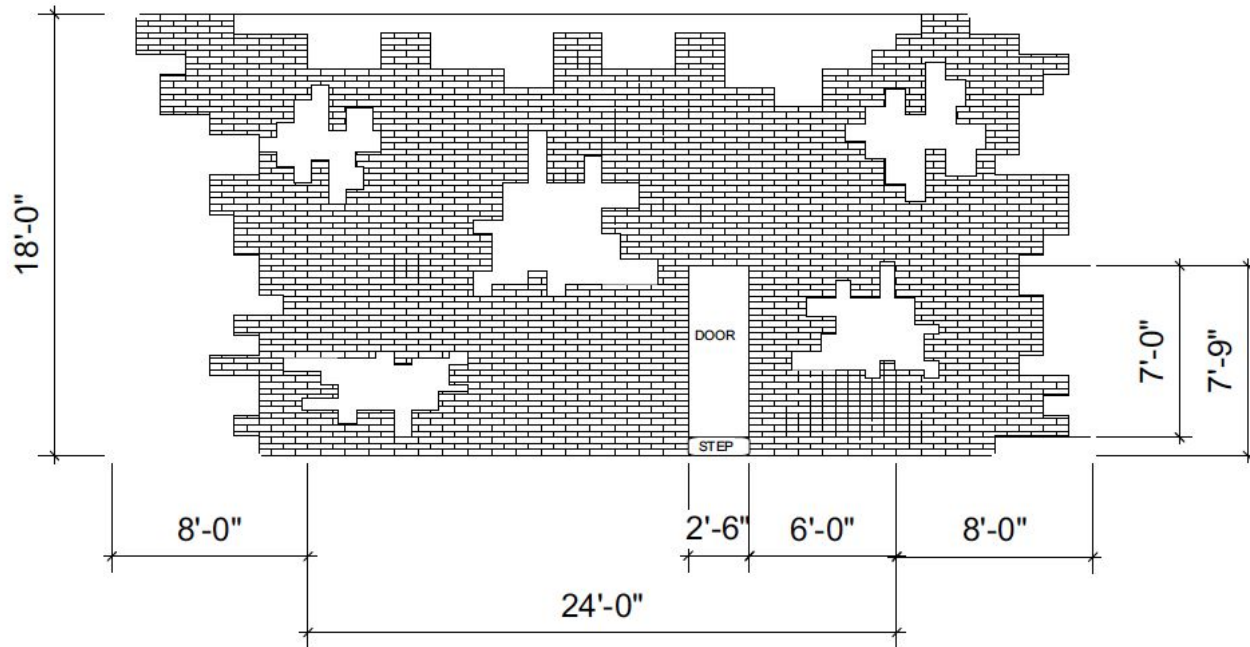

FRONT ELEVATION / DETAIL DRAWING	
BRICK WALL	
DRAFTER: NAOKO SKALA	
DATE: 3/10/2019	
SCALE: 1/4" = 1'-0"	5 OF 10

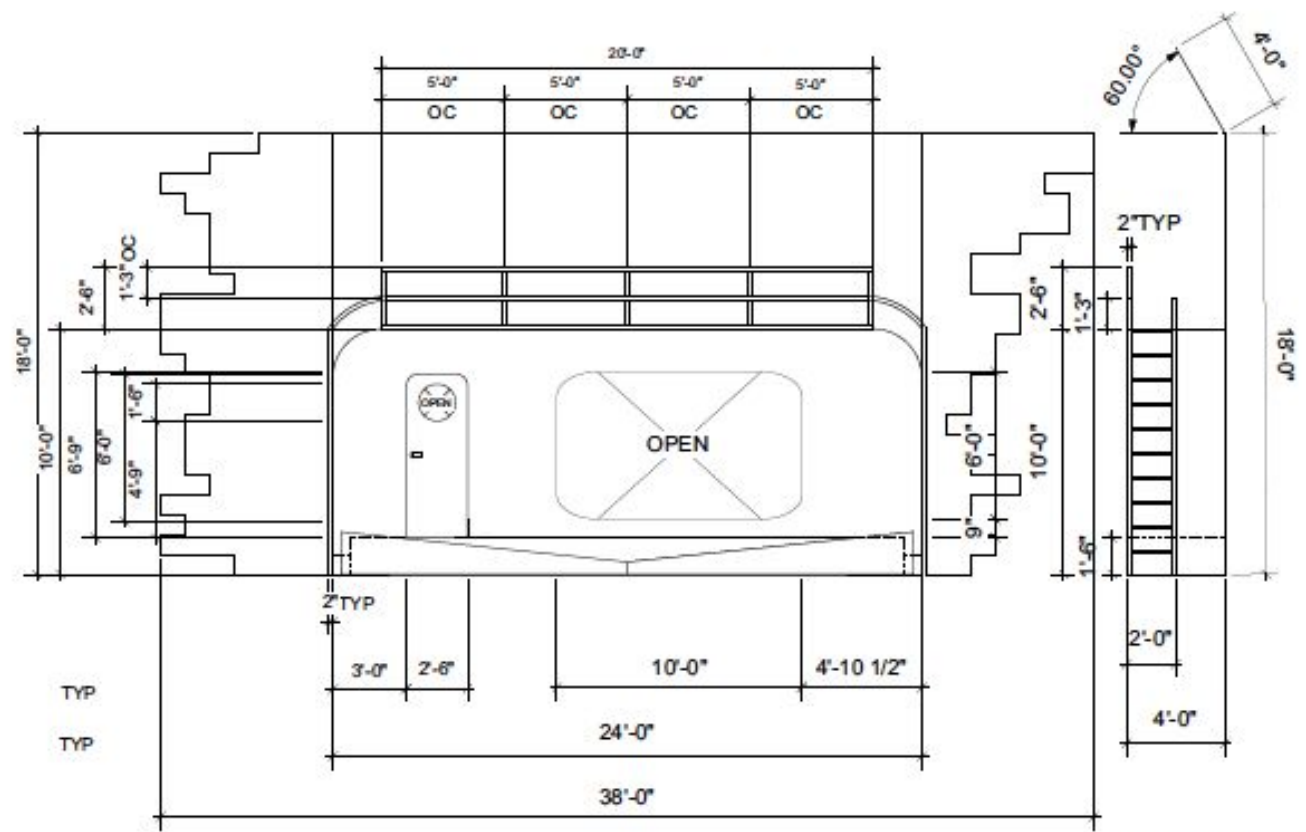

FRONT ELEVATION / DETAIL DRAWING	
SHIP DRAWING	
DRAFTER: NAOKO SKALA	
DATE: 3/13/2019	
SCALE: 1/4" = 1'-0"	6 OF 10

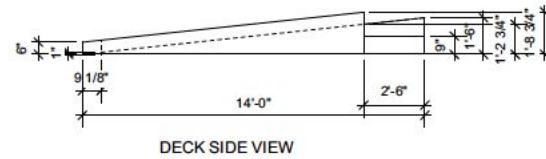
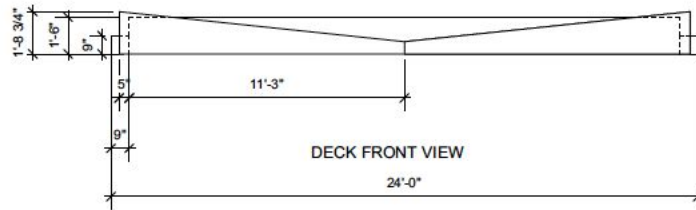
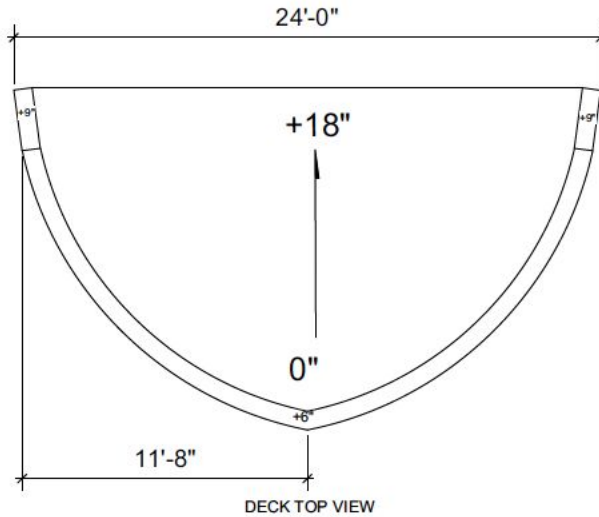

FRONT ELEVATION / DETAIL DRAWING	
DECK DETAILS	
DRAFTER: NAOKO SKALA	
DATE: 3/10/2019	
SCALE: 1/4" = 1'-0"	7 OF 10

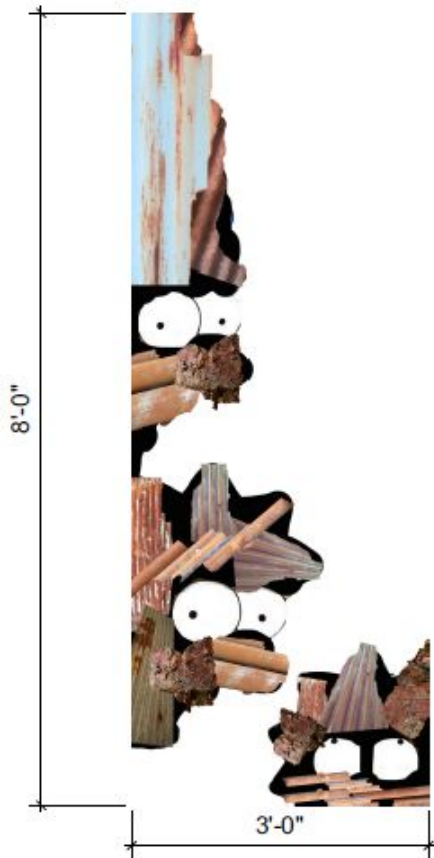

SR



SL

FRONT ELEVATION / DETAIL DRAWING

SIMPSON'S FLATS

DRAFTER: NAOKO SKALA

DATE: 4/4/2019

SCALE: 1" = 1'-0"

8 OF 10

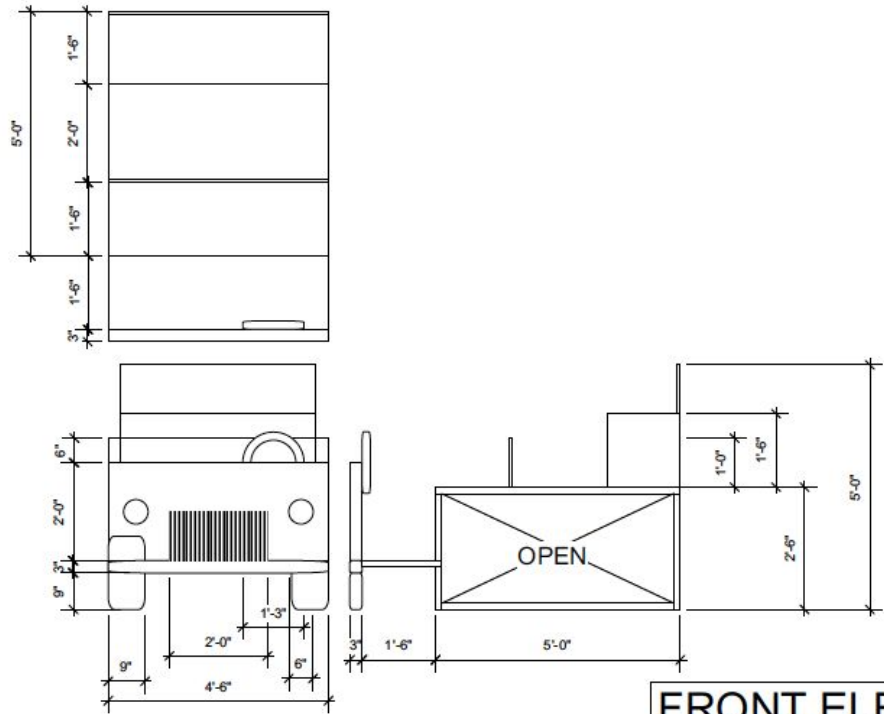

FRONT ELEVATION / DETAIL DRAWING	
CAR	
DRAFTER: NAOKO SKALA	
DATE: 3/13/2019	9 OF 10
SCALE: 1/2"= 1'-0"	

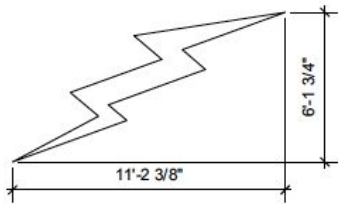
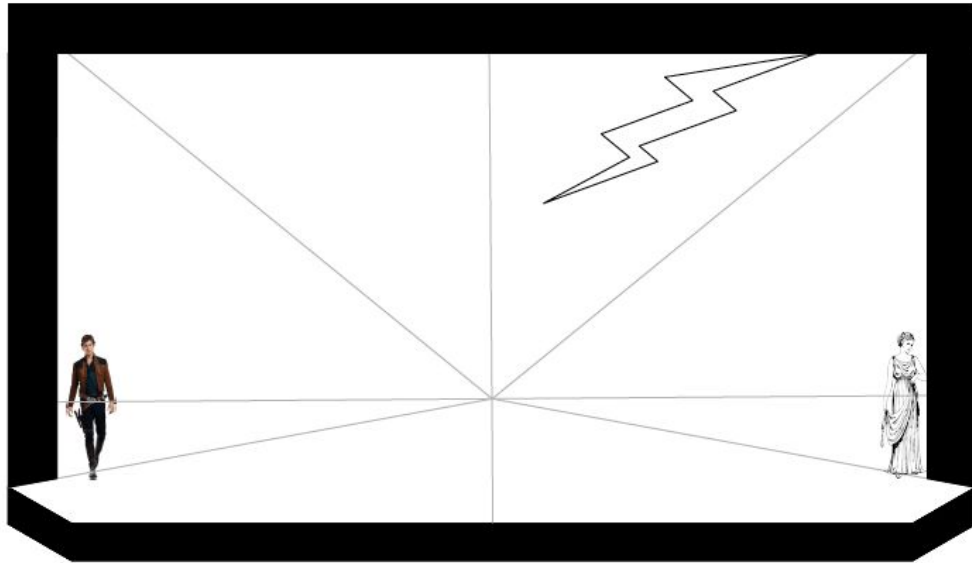

FRONT ELEVATION / DETAIL DRAWING	
LIGHTNING BOLT	
DRAFTER: NAKO SKALA	
DATE: 4/4/2019	
SCALE: 1/4" = 1'-0"	10 OF 10

Paint Sample



# Brick Wall 1



# Brick Wall 2

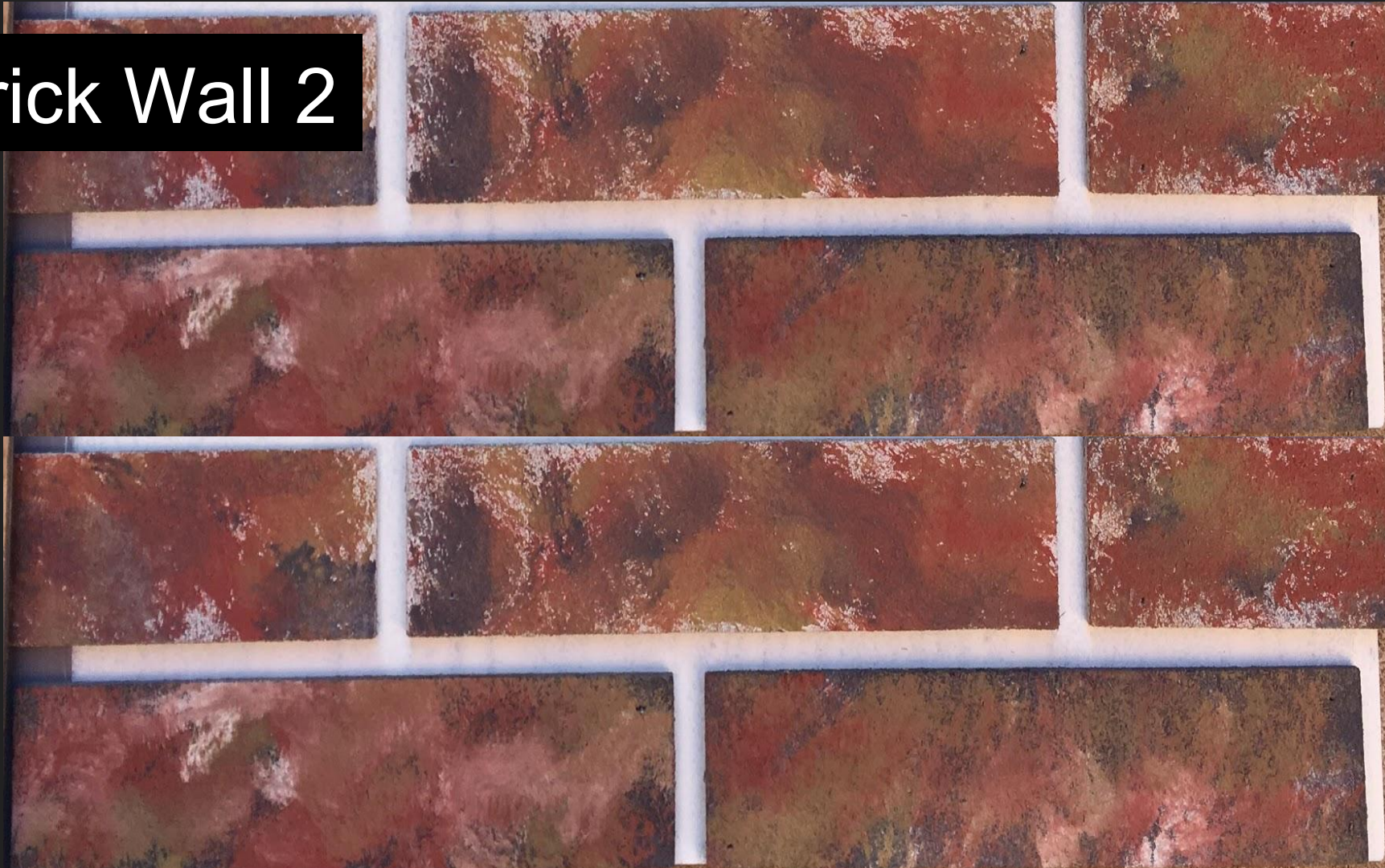

# Brick Wall 3



# Brick Wall 4

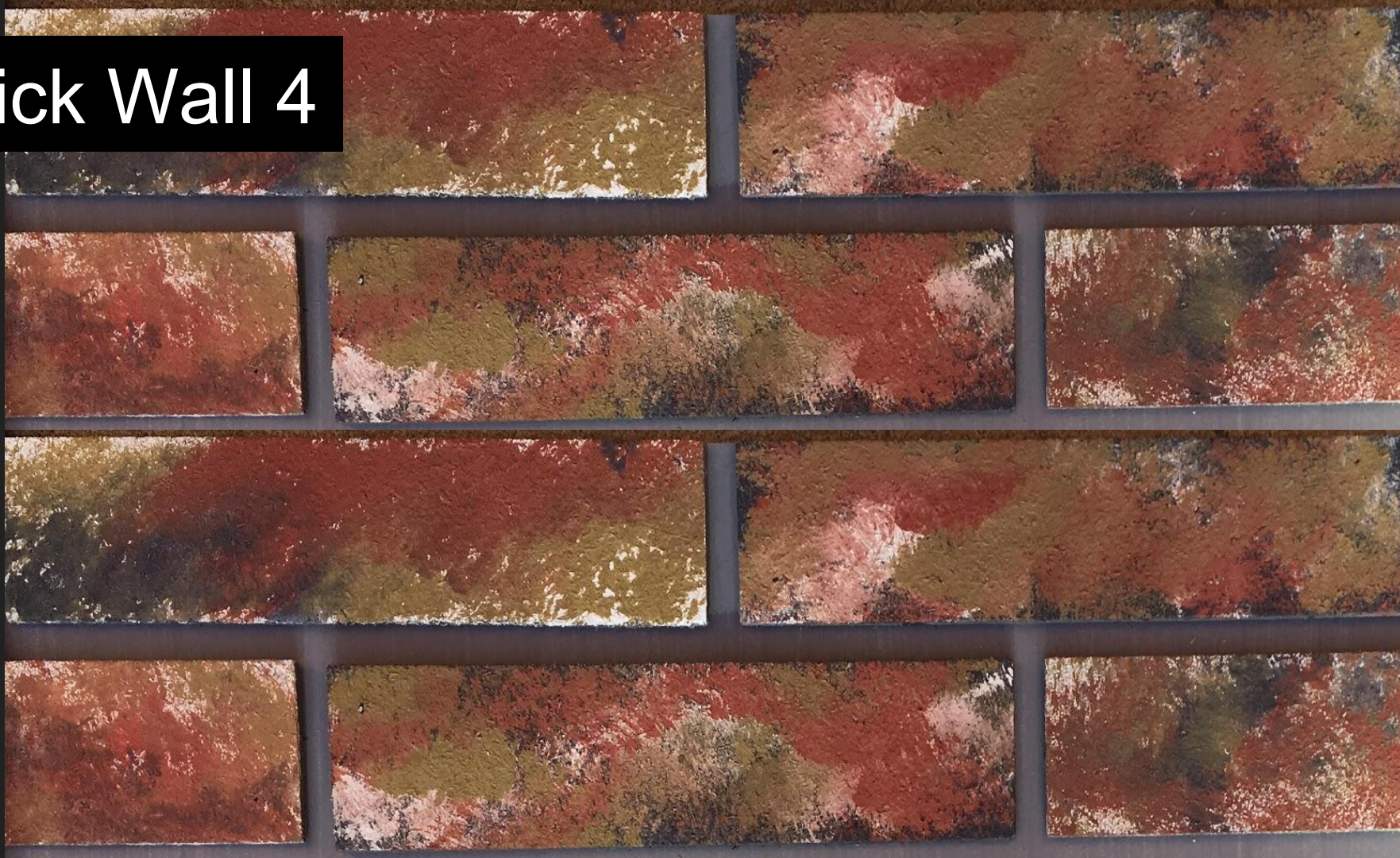

# Column Legs



# Ship Wall



# Deck Facing



# Deck





Thank you

